

Dimension including Mosquito Screen

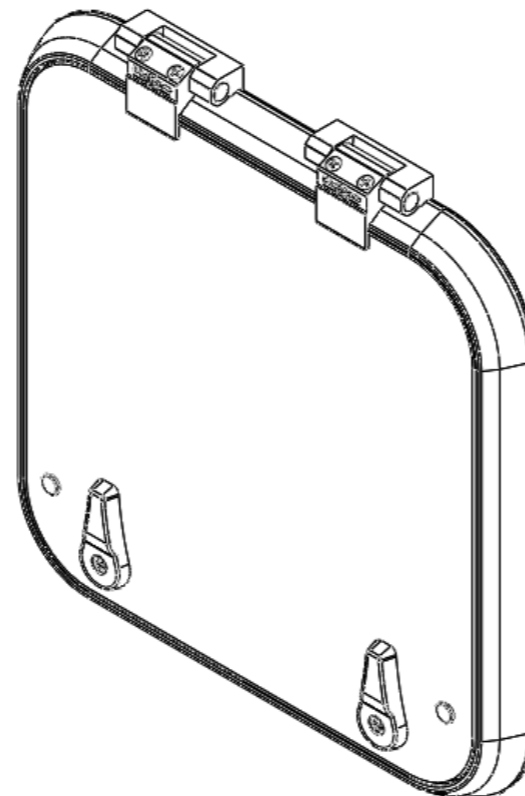

Note : Dimension Tolerance ± 2 mm

Surface Finish					
Ra Value μm	0.012 / 0.025	0.05 / 0.1	0.2 / 0.4	0.8 / 1.6	3.2 / 6.3 / 12.5 / 25 / 50 / 100
	120 to 315: ± 0.5	315 to 1000: ± 0.8	1000 to 2000: ± 1.2		
	0 to 6 : ± 0.1	6 to 30 : ± 0.2	30 to 120 : ± 0.3		

General Tolerances where not specified

Date	Revision	Description	Initials
		Assembly Sirius 410x410 R-55	
Description			Dwg.no.
			FB.010.20055
Material:	Heat Treatment:	Weight: gms/Unit	
Scale: N.T.S	Proj.:	Date: 19/08/09	
Drawn: R.Shankar	Checked:	Size: A3L	Dim. in: mm
Product group: Craftsman Marine	Sheet: 1	of: 1	



Craftsman
MARINE

Visersdijk beneden 70, 3319GV Dordrecht, The Netherlands. Tel: +31 (0)88 0062600, Fax: +31 (0)88 0062601 - info@craftsmanmarine.com - www.craftsmanmarine.com
This drawing is the property of Craftsman Marine B.V., Dordrecht. Copyright reserved acc. law. It is not to be copied (in whole or in part) or otherwise disclosed without the written consent of Craftsman Marine B.V.